



**HONG KONG PIEZO CO. LTD.**  
**香港功能陶瓷有限公司**

## Piezoceramic Buzzers

Model No: HKP-24L-40

Unit: mm

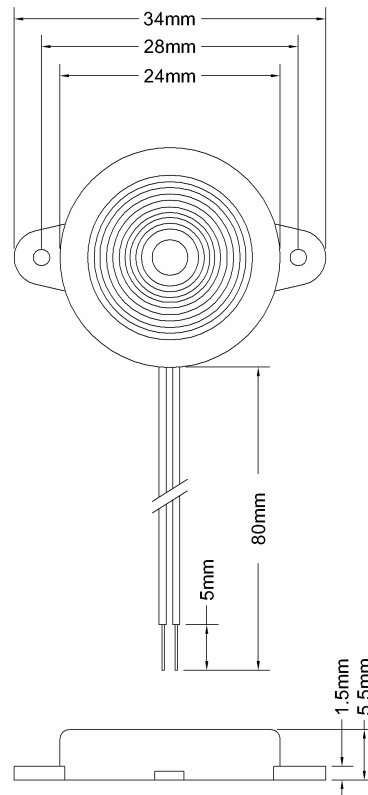

No.	Item	Specification
1	Dimension	Ø24.0 x H5.5mm
2	Sound Pressure Level	85dB min at 10cm 3Vrms Sine wave
3	Resonant Frequency	4.0±0.5KHz
4	Capacitance	20nf ± 30%
5	Operating Voltage	30Vp-p max
6	Operating Temperature	-20°C ~+70°C
7	Leads	AWG30# - UL1007